

REV		SH-T	DESCRIPTION	DATE	ECN	CHECKED
A	ALL	RELEASE	NEW	3/28/04	NEW	RBS

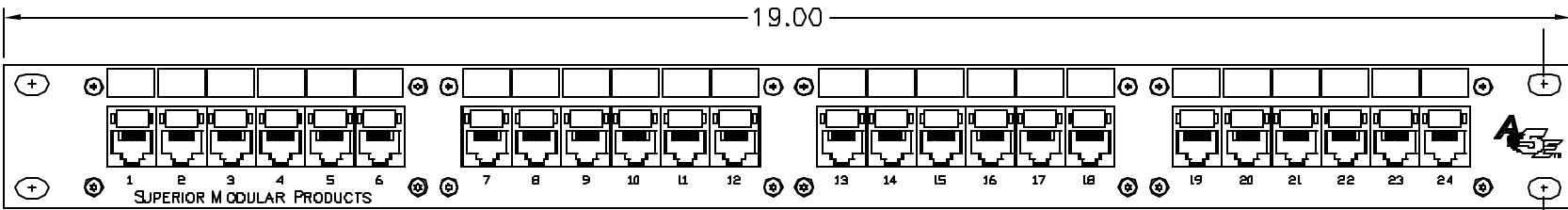

FRONT VIEW

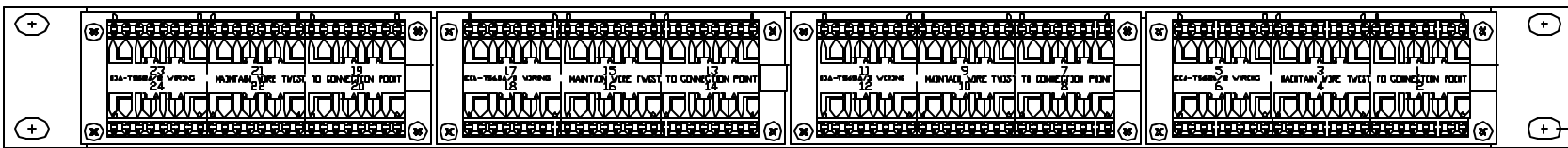

BACK VIEW

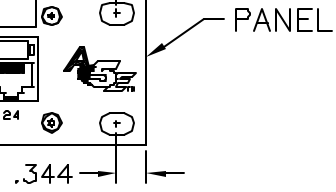

RIGHT SIDE

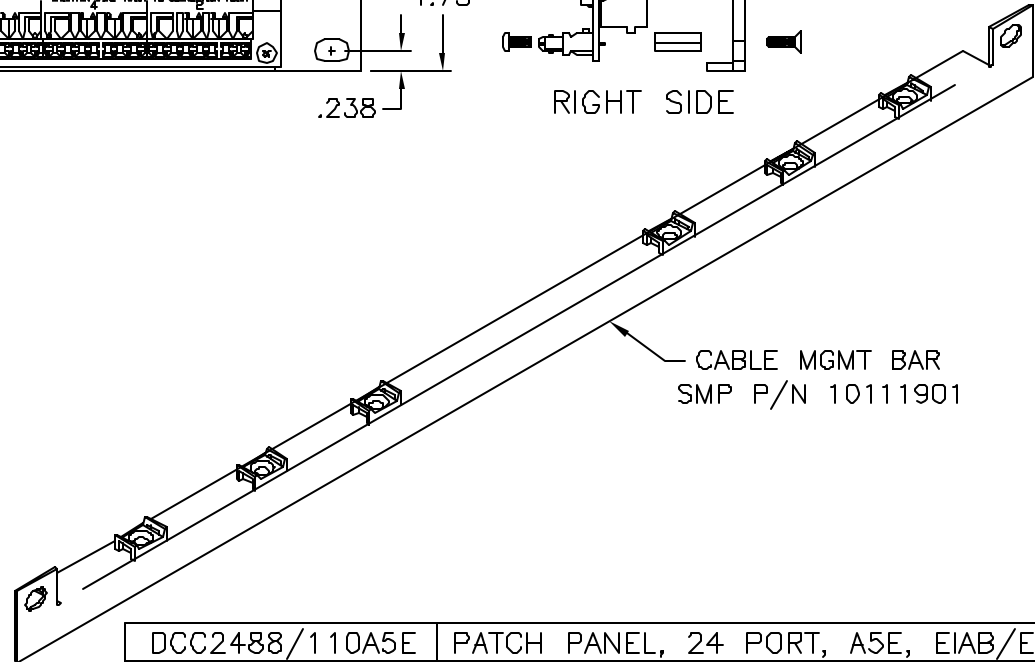

**SPECIFICATIONS**

**APPLICATION SUPPORT LIST:**

- VOICE
- 100 VG ANY LAN
- 155/622MBPS ATM
- 4/16 MBPS TOKEN RING
- 10 BASE-T ETHERNET
- 100 BASE-TX FAST ETHERNET
- 1000 BASE-T GIGABIT ETHERNET
- BROADBAND VIDEO
- 270 MBPS DIGITAL VIDEO
- ALL OTHER APPLICATIONS DEVELOPED FOR OPERATION OVER CATEGORY 5E OR CLASS D CABLING.

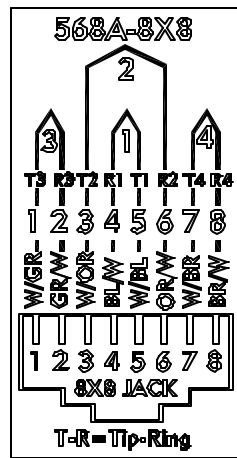
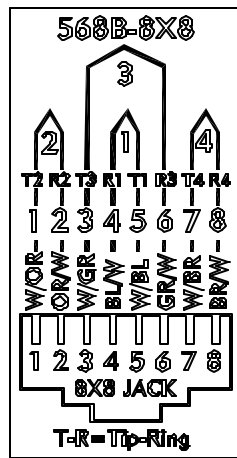

**FEATURES/MATERIALS:**

- CONSTRUCTED OF EXTRUDED AIRCRAFT GRADE BLACK ANODIZED ALUMINUM OR COLD ROLLED STEEL, DIMENSIONS AND MOUNTING HOLES PER EIA-310-D.
- ALL PLASTIC COMPONENTS ARE HIGH IMPACT SELF-EXTINGUISHING RATED 94V-0.
- CIRCUIT BOARD MATERIALS ARE FIBERGLASS/EPOXY FR-4 SOLDER MASKED ON BOTH SIDES.
- MODULAR JACK CONTACTS ARE HIGH-STRENGTH PHOSPHOR BRONZE OR BECU ALLOY WITH 50 MICRO-INCHES OF GOLD OVER 100 MICRO-INCHES OF NICKEL (OR EQUIVALENT AU/PD/NI PROCESS)
- 110 IDC CONTACTS ARE PHOSPHOR BRONZE PLATED WITH TIN, AND FIRE-RETARDANT PLASTIC.
- UL LISTED.
- CSA CERTIFIED.

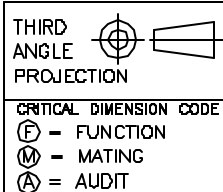

THIRD ANGLE PROJECTION

MATERIAL PANEL: CRS 18 GAGE BLOCK & CONN BODY: POLYCARBONATE UL RATING UL94 V-0

FINISH PANEL: PAINTED BLACK PER SMP SPEC NO. 10002501

DCC2488/110A5E	PATCH PANEL, 24 PORT, A5E, EIAB/EIAA
SMP PART NO.	DESCRIPTION

**UNCONTROLLED COPY**

UNLESS OTHERWISE SPECIFIED DIMENSIONS ARE IN INCHES TOLERANCES: FRACTIONS ±1/32" ANGLES ±1/2° 3 PLACE DECIMALS ±.005" 2 PLACE DECIMALS ±.01"		THIS DRAWING AND THE DESIGN SHOWN ARE THE PROPERTY OF SUPERIOR MODULAR PRODUCTS INC. AND MAY NOT BE USED AS THE BASIS FOR MANUFACTURE OR SALE WITHOUT SPECIFIC WRITTEN PERMISSION OF SUPERIOR MODULAR PRODUCTS.	
DRAWN BY	D.A.HOLBERT	DATE	3/28/04
CHECKED BY	R.B.SMITH	DATE	3/31/04
ENGINEER	J.YANK	DATE	3/28/04
APPROVED	B.EVERETTE	DATE	3/31/04
PREVIOUS DWG			
NEXT DWG	FILENAME	C106258A.DWG	



DWG TITLE		SIZE	DWG NO.	REV
PATCH PANEL ASSEMBLY, 24 PORT, A5E, EIAB/EIAA		B	C106258	A
SCALE	NONE	SHEET	1 OF 1	